

Moniteur médical 27" BriteMED[®]

L'écran Haute luminosité pour l'imagerie chirurgicale

BriteMED



Pied non fourni



Points forts



Connexion polyvalente

Entrées multiples permettant différentes connexions en fonction de l'utilisation : entrées VGA et DVI en standard, entrée / sortie HDMI avec fonctions PIP / PBP et module 3G-SDI en option pour les systèmes d'endoscopie avancés.



Visualisation précise des images

Le respect de la norme DICOM / GAMMA assure un rendu de couleur et une échelle de gris optimisés pour la visualisation fidèle de l'image médicale.



Brillance exceptionnelle

La luminosité élevée de 700 Cd/m² améliore la clarté et les détails pour la couleur et les images en niveaux de gris.



Imagerie multimodes

Les paramètres image dans l'image (PIP) et image par image (BPB) permettent une capacité d'affichage multimodes pour diverses combinaisons d'images.

Guide de sélection

	for general connection	With analog video input for traditional system	With 3G-SDI input for advanced system
Without HDMI Input/output	MMS-27C	MMS-27CA	MMS-27CS MMS-27CAS
With HDMI Input/output for PIP/PBP Display	MMS-27CH	MMS-27CAH	MMS-27CHS MMS-27CAHS

Caractéristiques

Model		MMS-27C	MMS-27CA	MMS-27CH	MMS-27CAH	MMS-27CS	MMS-27CAS	MMS-27CHS	MMS-27CAHS
Description		General VGA, DVI inputs	Multiple analog inputs	VGA, DVI, and HDMI inputs	VGA, DVI, analog, and HDMI inputs	VGA, DVI, and 3G-SDI inputs	Analog and 3G-SDI inputs	HDMI and 3G-SDI inputs	Analog, HDMI, and 3G-SDI inputs
Picture Performance	LCD Size	27" (16:9)							
	Panel Type	Color (IPS)							
	Backlight	LED							
	Resolution	1920 (W) x 1080 (H) pixels							
	Brightness (max.)	700 nits (typical)							
	Contrast Ratio	1000:1 (typical)							
	View Angle (H/V)	178° / 178° (typical)							
	Color Temperature	Factory calibrated 5500K, 6500K, 7500K, 9300K							
	Gamma Correction	Factory calibrated gamma 2.0 & DICOM							
Function	Function Keys	1 x MENU 1 x Input source 1 x Custom input			1 x Backlight up /+ 1 x Backlight down / - 1 x Image size adjustment				
Input	VGA (DB-15)	1							
	DVI-D	1							
	HDMI	N/A	N/A	1	1	N/A	N/A	1	1
	Component	N/A	BNC x 5 (Y/Pb/Pr, R/Gs/B, R/G/B/C-Sync, R/G/B/H-Sync/V-Sync)	N/A	BNC x 5 (Y/Pb/Pr, R/Gs/B, R/G/B/C-Sync, R/G/B/H-Sync/V-Sync)	N/A	BNC x 5 (Y/Pb/Pr, R/Gs/B, R/G/B/C-Sync, R/G/B/H-Sync/V-Sync)	N/A	BNC x 5 (Y/Pb/Pr, R/Gs/B, R/G/B/C-Sync, R/G/B/H-Sync/V-Sync)
	CVBS	N/A	BNC x 1 (NTSC, PAL)	N/A	BNC x 1 (NTSC, PAL)	N/A	BNC x 1 (NTSC, PAL)	N/A	BNC x 1 (NTSC, PAL)
	S-Video	N/A	1	N/A	1	N/A	1	N/A	1
	3G-SDI	1							
	Audio	Phone jack x 1							
Output	HDMI	N/A	N/A	1, loop through	1, loop through	N/A	N/A	1, loop through	1, loop through
	Component	N/A	BNC x 5, loop through (Y/Pb/Pr, R/Gs/B, R/G/B/C-Sync, R/G/B/H-Sync/V-Sync)	N/A	BNC x 5, loop through (Y/Pb/Pr, R/Gs/B, R/G/B/C-Sync, R/G/B/H-Sync/V-Sync)	N/A	BNC x 5, loop through (Y/Pb/Pr, R/Gs/B, R/G/B/C-Sync, R/G/B/H-Sync/V-Sync)	N/A	BNC x 5, loop through (Y/Pb/Pr, R/Gs/B, R/G/B/C-Sync, R/G/B/H-Sync/V-Sync)
	CVBS	N/A	BNC x 1, loop through (NTSC, PAL)	N/A	BNC x 1, loop through (NTSC, PAL)	N/A	BNC x 1, loop through (NTSC, PAL)	N/A	BNC x 1, loop through (NTSC, PAL)
	S-Video	N/A	1, loop through	N/A	1, loop through	N/A	1, loop through	N/A	1, loop through
	3G-SDI	N/A	N/A	N/A	N/A	1, loop through			
	Audio	0.8W x 2							
General	Power Requirement	10V-28V DC input							
	Power Adaptor	Medical grade power adaptor: input: 100-240V AC 50-60Hz; output: 12V DC/7.5A							
	Dimensions	657 (L) x 399 (W) x 59.5 (H) mm							
	Weight	10 kg							
	Mounting Standard	VESA 100 x 100 mm / 200 x 100 mm							
Environment	Operating Temperature	0°C-40°C							
	Operating Humidity	10%-90% (non-condensing)							
	Storage Temperature	-20°C -60°C							
	Storage Humidity	10%-90% (non-condensing)							
	Certifications & Compliance	ANSI/AAMI ES60601-1, EN60601-1, CAN/CSA C22.2 No. 60601-1, and FCC Class B part 18							
Package Content	Monitor	1	1	1	1	1	1	1	1
	Power Adaptor	1	1	1	1	1	1	1	1
	Power Cord	1	1	1	1	1	1	1	1
	Grounding Cable	1	1	1	1	1	1	1	1
	VGA Cable	1	1	1	1	1	1	1	1
	DVI Cable	1	1	1	1	1	1	1	1
	HDMI Cable	N/A	N/A	1	1	N/A	N/A	1	1
	USB Cable	1	1	1	1	1	1	1	1
User Manual (USB flash drive)	1	1	1	1	1	1	1	1	

Dimensions (mm)

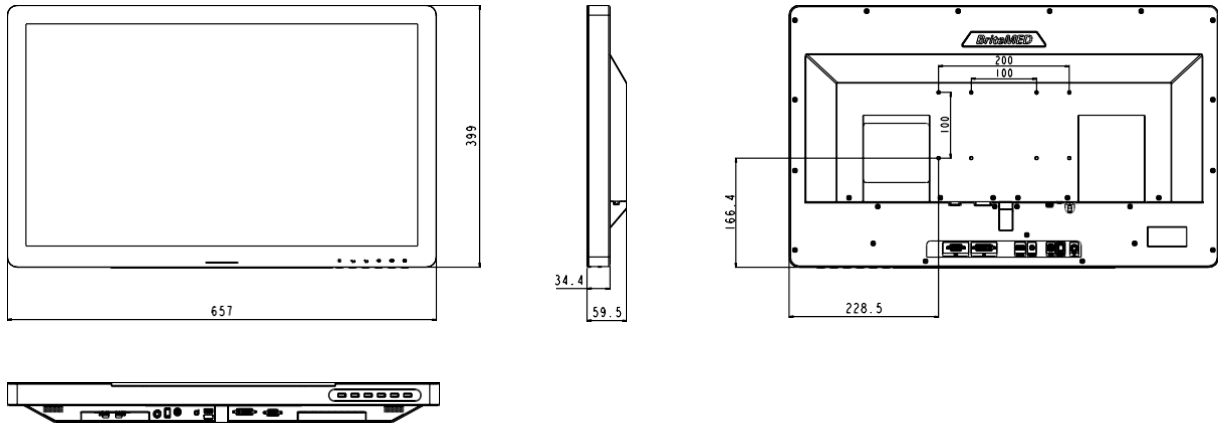

I/O Interface

MMS-27C

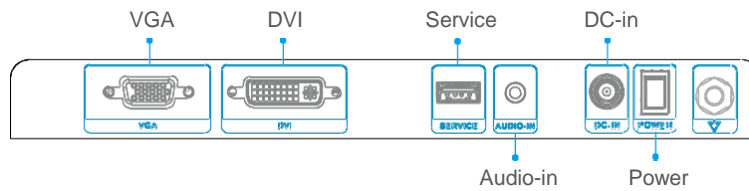

MMS-27CA

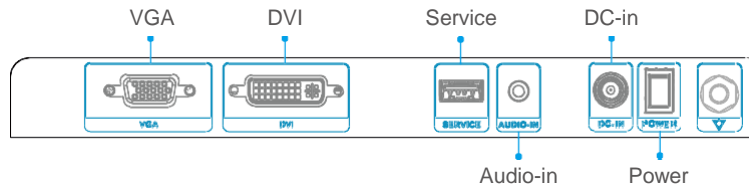
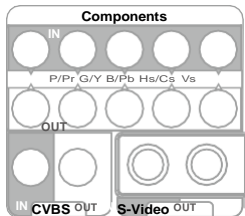

MMS-27CH

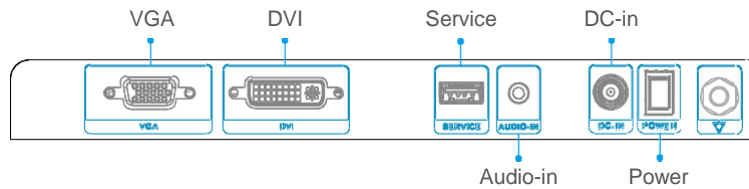

MMS-27CAH

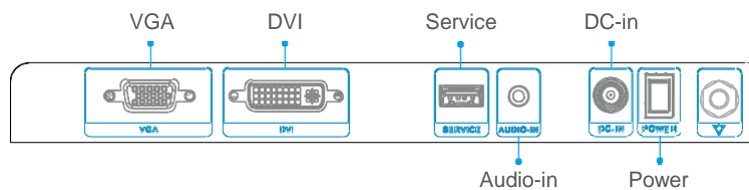
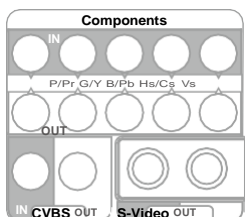

MMS-27CS

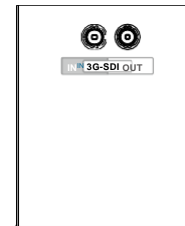
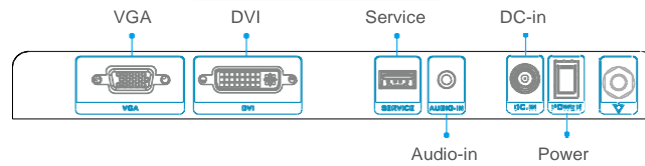

MMS-27CAS

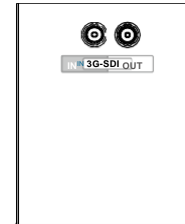
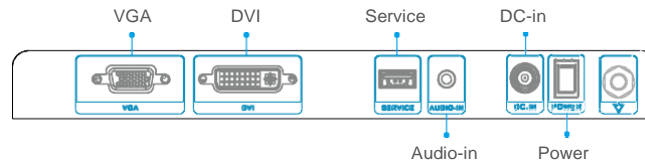

MMS-27CHS

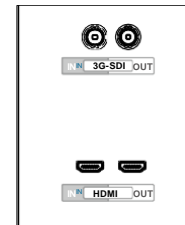
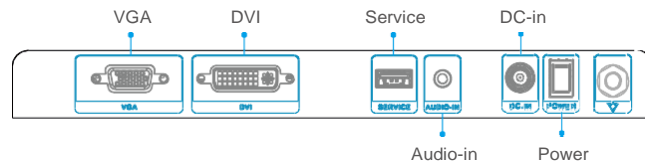

MMS-27CAHS

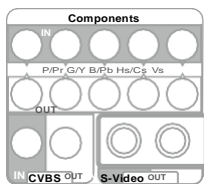
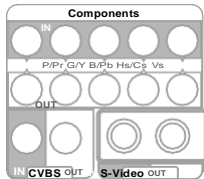
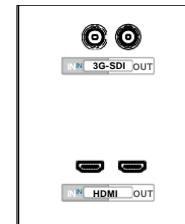
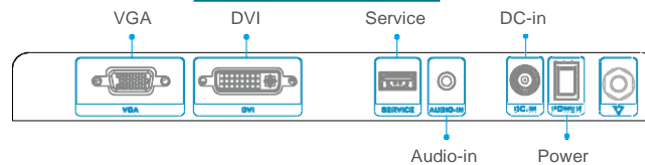

Ordering Information

Part No.	Description
MMS-27C-R10	27" 1920x1080 color monitor, VGA/DVI-D input, 100-240V AC to 12V DC power adaptor
MMS-27CA-R10	27" 1920x1080 color monitor, VGA/DVI-D/Component/CVBS/S-Video input, 100-240V AC to 12V DC power adaptor
MMS-27CH-R10	27" 1920x1080 color monitor, VGA/DVI-D/HDMI input, 100-240V AC to 12V DC power adaptor
MMS-27CAH-R10	27" 1920x1080 color monitor, VGA/DVI-D/Component/CVBS/S-Video/HDMI input, 100-240V AC to 12V DC power adaptor
MMS-27CS-R10	27" 1920x1080 color monitor, VGA/DVI-D/3G SDI input, 100-240 VAC to 12V DC power adaptor
MMS-27CAS-R10	27" 1920x1080 color monitor, VGA/DVI-D/Component/CVBS/S-Video/3G SDI input, 100-240 VAC to 12V DC power adaptor
MMS-27CHS-R10	27" 1920x1080 color monitor, VGA/DVI-D/HDMI/3G SDI input, 100-240 VAC to 12V DC power adaptor
MMS-27CAHS-R10	27" 1920x1080 color monitor, VGA/DVI-D/Component/CVBS/S-Video/HDMI/3G SDI input, 100-240 VAC to 12V DC power adaptor

Factory Options

Part No.	Description
STAND-DWH-R10	VESA 75/100 stand, supports up to 15 kg, white
WK-E35M-R10	VESA 100/200/200x100 wall mount kit, supports up to 35 kg, silver